

HOT WATER SYSTEMS

CONTENTS

MECHANICAL CONSIDERATIONS	3
Code Considerations	3
Boiler Selection Considerations	3
Air Removal	4
Expansion Tank	4
Pressure Drop	8
Domestic Hot Water	8
Heating/Cooling	10
Accumulators	11
Safety	11
High Temperature Water Boilers	11
CONTROL CONSIDERATIONS	12
Temperature Control	12
Lead/Lag Systems	14
Temperature Setbacks	16
Heat Users	17
WATER CONSIDERATIONS	20
Water Conditioning	20
Chemical Treatment	20
Make-up Water	20
Ethylene Glycol as Heat Transfer Medium	21
SYSTEM DIAGRAMS	22

ILLUSTRATIONS

Typical Expansion Tank Piping Arrangement	5
Typical Pump Curve	5
Pressure Temperature Chart for Firetube Boilers	7
Plug Cock or Gate Valve (Manual Operation)	15
Two-Position Valve (Electric or Pneumatic)	15
Throttling or Modulating Valve (Electric or Pneumatic)	15
Three-Way Mixing Valve	15
Three-Way Mixing Valve (By-Pass Arrangement)	16
Three-Way Diverting Valve	16
Intermittent Secondary Pump Operation (On-Off)	16
Water Temperature Constant Thru Zone Bypass	16
Continuous Secondary Pump Operation with Two-Position Valve (Valve Open)	17
Continuous Pump Operation with Two-Position Valve (Valve Closed)	17



Hot Water Systems

Primary Loop Circuit, Constant Speed Pumps	23
Primary Loop Circuit with Secondary Pumping	24
Individual Zone Circuits	25
Primary Loop Circuit with Three-Way Valve	26
Four-Way Valve System	27
Multiple Boiler Lead/Lag, Primary/Secondary Pumping	28

TABLES

Circulation Rates	6
Pressure drop across firetube hot water boilers (standard size nozzles)	9

This section provides design considerations for boiler applications in hot water systems. The information provided is intended to create an awareness of the conditions necessary for a successful installation and long boiler life.

MECHANICAL CONSIDERATIONS

Code Considerations

Boilers constructed in accordance with Section IV, Heating Boilers, of the ASME Boiler and Pressure Vessel Code can be operated with water temperature up to 250 °F with a maximum design pressure of 160 psig.

Boilers for operation over 250 °F or 160 psig must be constructed in accordance with Section I, Power Boilers, of the ASME Boiler and Pressure Vessel Code.

Due to limitations of control and safety settings, desired operating temperatures between 240 °F and 250 °F may require the use of a Section I boiler. System operating pressure must not exceed 90% of the relief valve pressure setting.

Consideration should be given to system piping to ensure it meets all applicable codes. For example, when Section I boilers are used, the piping must be in accordance with B31.1 ASME Power Piping Code.

Boiler Selection Considerations

When a hot water system is laid out, all of the components must be selected to work together to achieve the design intent. The design intent could include criteria such as: system flexibility, maximum efficiency, heating/cooling, domestic hot water, heat storage, fuel capability, etc. Selection and operation of the boiler(s) in relation to the other system components, and in support of the design intent, are important considerations.

Selection of a boiler to support the design intent of the hot water system is dependent on several site-specific variables, such as those just listed. In addition, one of the most important selection factors is the maximum continuous rating of the boilers, which is dependent on the load imposed by the “heat users” and the nature of the load. For example, consider an installation with a maximum load of 10,300,900 Btu/hr. Of this, 9,300,900 Btu/hr are the peak winter heating load and 1,000,000 Btu/hr are domestic hot water load, which are provided through means of a heat exchanger.

Based on the maximum load conditions just described, consideration might be given to a 310 horsepower firetube boiler (1 boiler horsepower = 33,472 Btu/hr). However, to ensure system flexibility, and to provide some degree of stand-by for unscheduled outage, common practice would dictate the installation of two units, each with a capacity of 65% of the maximum load. That is; two 200 horsepower units, or 6,695,000 Btu/hr each.

Based on the example just mentioned, it is apparent that boiler capacity selection, based on peak loading, is fairly straight forward.

Specific load mix, often caused by early fall or late spring heating loads, can require additional considerations. When the minimum heating load is 10% of the maximum heating load, the heating load is: 9,300,900Btu/hr.

Heating Load @ 10% = 930,090Btu/hr

Domestic Water = 1,000,000Btu/hr

TOTAL LOAD = 1,930,090Btu/hr

When the light heating load only is imposed, the demand on the boiler is only 14% of its rated capacity. A third, smaller unit should be considered for “light” load conditions, unless the boiler has a burner with a 10:1 turndown ratio.

When multiple boilers are used, care must be taken to assure proper proportional flow through each of the units. If flow is not properly balanced, wide variations in boiler firing rates can occur and, in extreme cases, the resulting outlet water temperatures may not be at the desired point.

In summary, the seasonal and daily variations define the size of the load that the boilers must handle. The maximum load will be used, along with backup requirements, to set the

plant capacity. Seasonal and daily variations are used to help select the number of boilers and turndown requirements. In some applications, there is a mixture of loads. These may be different types of process loads or combinations of heating and process loads. It is usually best to analyze them individually, and then combine them for each season.

Air Removal

Air removal in a hot water boiler is important for two main reasons. Air contains oxygen, which can cause corrosion of metal surfaces. And, air acts as an insulator and can affect heat transfer as well the operation of temperature controls.

All Cleaver-Brooks hot water outlet connections include a dip tube, which extends 2 to 3 inches into the boiler. The dip tube does not allow any air, which may be trapped at the top of the drum, to get back into the system.

Because any oxygen or air which is released in the boiler will collect or be trapped at the top of the boiler drum, the air vent tapping on the top center line of the boiler should be piped into the expansion or compression tank or fitted with an automatic air vent valve. Any air that is trapped at the top of the boiler will find its way out of the boiler through this tapping.

Dip tube assemblies furnished for external mounting into the boiler return connection, or system air separators, may also be equipped with an air vent tapping. These devices will remove air from the system, however, they do not remove air from the top of the boiler. To avoid trapped air at the top of the boiler drum, it is still necessary to pipe the boiler air vent into the expansion or compression tank or into an automatic air vent valve.

Expansion Tank

An expansion tank serves one primary function in a hot water system. It provides a means for the system water to expand, as it is heated, without significantly increasing system pressure.

Expansion tanks are also often used as the receiver for the air removed from the boiler. This is convenient if the expansion tank does not have a bladder or diaphragm. If the expansion tank has a bladder or diaphragm, the air from the boiler must be removed by an automatic type air vent piped directly to the air vent tapping on the top of the boiler.

Proper expansion tank design will account for the desired system pressure and changes in the specific volume of water from 60 °F (ambient temperature) to the maximum operating temperature of the boiler and related system. To design the expansion tank, you must first know the total volume of water in the flooded boiler and system. For flooded values for a Cleaver-Brooks boiler, refer to the boiler products section. You will need to estimate the water volume in the system by considering the diameter and length of system piping and including the volume of water contained in system heat exchangers.

Expansion tanks are usually charged with air or an inert gas such as nitrogen. Nitrogen is often used in high temperature water applications due to its low corrosive nature. Regardless of the charging media, expansion tanks are charged at a pressure slightly higher than the static pressure on the tank with the system at ambient temperature. As the water in the system is heated, the air or gas cushion in the expansion tank compresses, allowing the water to expand without significant variations to the system pressure.

For more information on sizing expansion tanks, refer to the ASHRAE Guide Book, or contact your local Cleaver-Brooks authorized representative.

A typical expansion tank piping arrangement is shown in Figure 1.

Pumping Equipment

Pump Type

Centrifugal type pumps are typically used for system circulating pumps, because of their proven durability, efficiency, and ability to pump the required flow and pressure.

Although there are many types of centrifugal pumps available with varying characteristics, most applications use a pump with a curve similar to Figure 2.

When using this type of pump curve, draw a horizontal line at the feet-of-head requirement

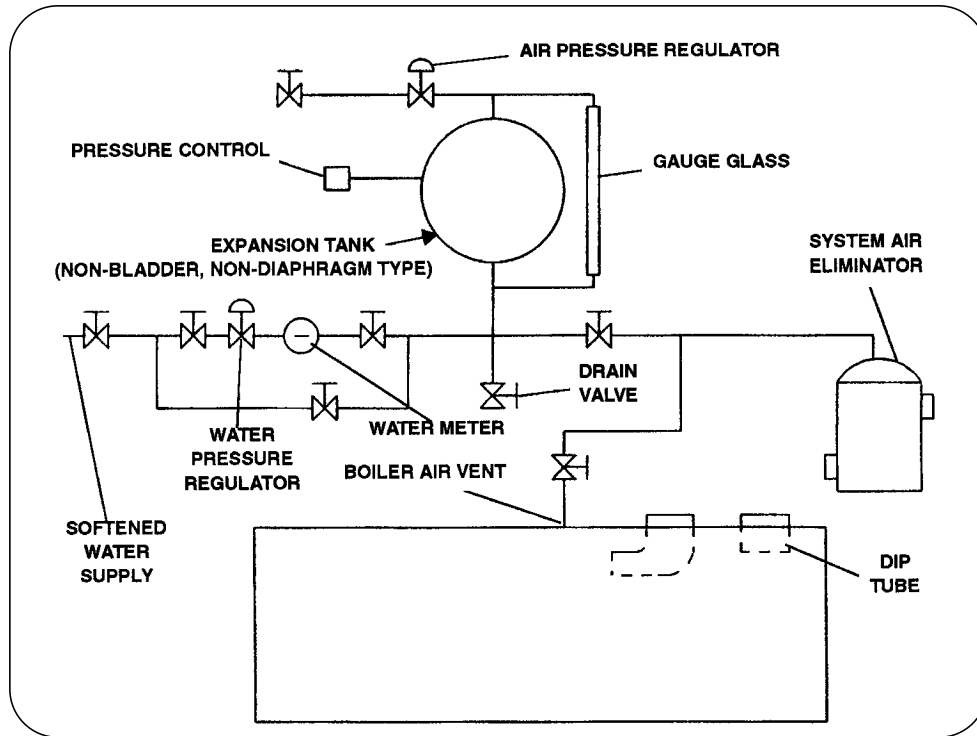

Figure 1. Typical Expansion Tank Piping Arrangement

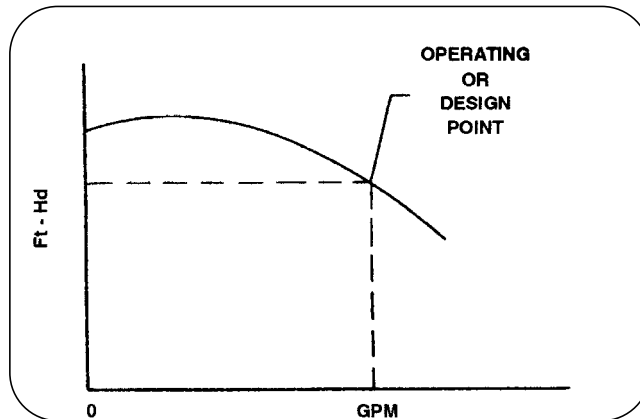

Figure 2. Typical Pump Curve

for the system (2.31 feet of water at 60 °F = 1 psig). At the point where the line intersects the pump curve, draw a vertical line to determine the gallon per minute flow the pump will pump at the given feet-of-head. Select a pump that meets both the flow and feet of head requirements for the system. The operating or design point of the pump is the point at which the vertical and horizontal lines intersect the pump curve. This point is also commonly referred to as the duty point.

Pump Location

It is recommended that the system circulating pumps take suction from the outlet connection on the boiler and that they discharge to the system load in order to put the boiler and the expansion tank on the suction side of the pump. This location is preferred because it decreases potential for air entry into the system and does not impose the system head on the boiler.

It is common practice to install a standby system circulating pump, to accommodate scheduled pump maintenance without shutting the system down. Usually, both the main and standby circulating pumps are located adjacent to the boilers in the boiler room.

Pump Operation

Pumps are normally started and stopped by manual switches. It is also desirable to interlock the pump with the burner so that the burner cannot operate unless the circulating pump is running.

Table 1. Circulation Rates

BOILER HP	BOILER OUTPUT (X 1000) BTU/HR	SYSTEM TEMPERATURE DROP - DEGREES F									
		10	20	30	40	50	60	70	80	90	100
		MAXIMUM CIRCULATING RATE - GPM									
15	500	100	50	33	25	20	17	14	12	11	10
20	670	134	67	45	33	27	22	19	17	15	13
30	1005	200	100	67	50	40	33	29	25	22	20
40	1340	268	134	89	67	54	45	38	33	30	27
50	1675	335	168	112	84	67	56	48	42	37	33
60	2010	402	201	134	101	80	67	58	50	45	40
70	2345	470	235	157	118	94	78	67	59	52	47
80	2680	536	268	179	134	107	90	77	67	60	54
100	3350	670	335	223	168	134	112	96	84	75	67
125	4185	836	418	279	209	168	140	120	105	93	84
150	5025	1005	503	335	251	201	168	144	126	112	100
200	6695	1340	670	447	335	268	224	192	168	149	134
250	8370	1675	838	558	419	335	280	240	210	186	167
300	10045	2010	1005	670	503	402	335	287	251	223	201
350	11720	2350	1175	784	587	470	392	336	294	261	236
400	13400	2680	1340	895	670	535	447	383	335	298	268
500	16740	3350	1675	1120	838	670	558	479	419	372	335
600	20080	4020	2010	1340	1005	805	670	575	502	448	402
700	23450	4690	2345	1565	1175	940	785	670	585	520	470
800	26780	5360	2680	1785	1340	1075	895	765	670	595	535

Note: Applications with design temperature drops over 50 degrees F require review by Cleaver-Brooks.

Pump Capacity

Table 1 can be used to determine the maximum gpm circulating rate in relation to full boiler output and system temperature drop. Knowing the boiler size and expected system temperature drop, the maximum circulation rate can be selected.

Circulation

The system should be piped and the controls configured to ensure continuous flow of system water through the boiler under all operating conditions. Constant circulation through the boiler results in a more even water temperature and eliminates the possibility of stratification within the boiler and system. Constant circulation reduces the possibility of thermal stresses to the boiler and subsequent pressure vessel failure.

Minimum Circulation

As a rule of thumb, the minimum continuous circulation rate through the boiler under operating conditions is one gallon per minute per boiler horsepower.

Maximum Circulation

The maximum circulation in gallons per minute through the boiler is based on system design temperature drop, and maximum Btu output rating of the boiler. Table 1 shows the maximum circulation rates for firetube boilers. For information on specific boiler circulation rates, refer to the boiler products section.

Pressure Drop

When sizing the system circulating pump, it is necessary to account for the system

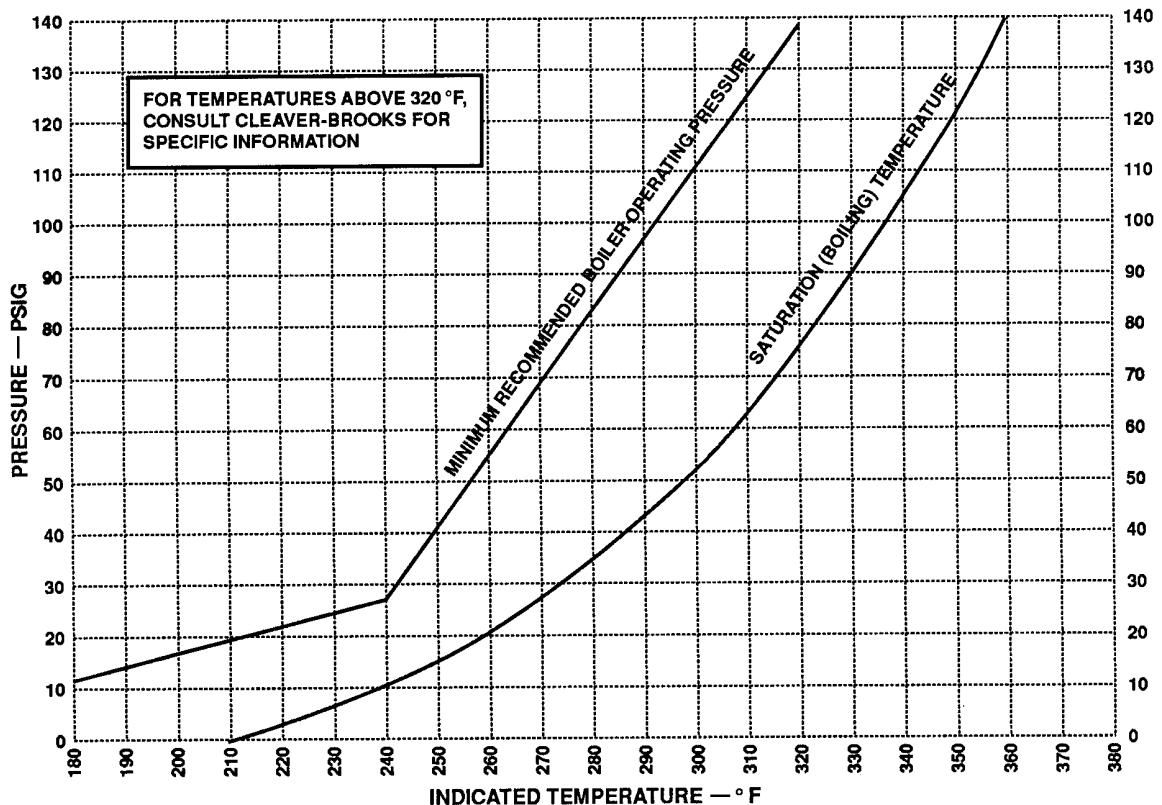

Figure 3. Pressure Temperature Chart for Firetube Boilers

line losses. Proper sizing will allow the pump to overcome the system pressures in order to deliver the proper flow through the system. The boiler is part of the system pressure drop calculation. As a rule of thumb, there is a pressure drop of less than 3 feet of head (1 psi = 2.31 feet of head) through Cleaver-Brooks boilers.

Table 2 shows pressure drop curves for firetube boilers with standard size nozzles. To determine the pressure drop for a particular application, find the flow rate in GPM on the y-axis and read across the graph to the boiler HP. The resulting x value will be the head loss in feet of water (note: scale is log-log).

Pressure Requirements

In a hot water boiler, the pressure/temperature relationship is critical. Unlike a steam boiler, where the pressure and temperature relationship corresponds to the laws of nature, a hot water boiler design purposely prevents the water from turning to steam. To prevent steaming, a certain amount of over pressure is required to keep the water from flashing to steam. Figure 3 shows a typical pressure/temperature relationship for Firetube and Model 4 hot water boilers. Similar charts are provided in the specific boiler product sections. To use the chart, locate the maximum system operating temperature (High Limit Control Setting) on the bottom line. Draw a straight line to the minimum recommended boiler operating pressure curve. At the point where the lines intersect, draw a horizontal line to the left of the chart and find the necessary pressure.

Domestic Hot Water

Hot water systems are often used as the energy source to provide domestic hot water. The hot water for personal washing (showers, laundry, etc.) and, in some cases, light industrial process, is often provided through the incorporation of a heat exchanger in the system.

Physically, the heat exchanger provides a separation of the hot water system water from the domestic water which, in turn, allows the fluids to be of different chemical make-up. This provides integrity and proper water treatment for the hot water system, and proper water treatment, while providing potable water in the secondary loop.

Space requirements for the domestic water heat exchanger vary considerably based on specific application. However, typically, the required space is quite small. For example, Cleaver-Brooks can provide domestic water coils integral to the boiler that require no additional floor space, and only need room for the associated domestic water loop piping. In this type of system, typically, there is a low volume of domestic water stored. The heat exchanger system must be sized to maintain minimum desired temperature at maximum load conditions. This is an excellent application for fairly continuous domestic water loads.

In many cases, domestic hot water can, and should, be provided by including a shell and tube (or plate and frame) heat exchanger as part of the hot water system. Isolation and services of the heat exchanger can be performed without removing the hot water heating system from service.

When it is apparent that large domestic water demands are required for a short period of time, consideration should be given to incorporating a storage tank in the domestic water loop. In most applications of this type, the heat exchanger is incorporated into the storage tank and the hot water system fluid is pumped through the "tube" side of the exchanger and the domestic hot water is on the

Table 2. Pressure drop across firetube hot water boilers (standard size nozzles)

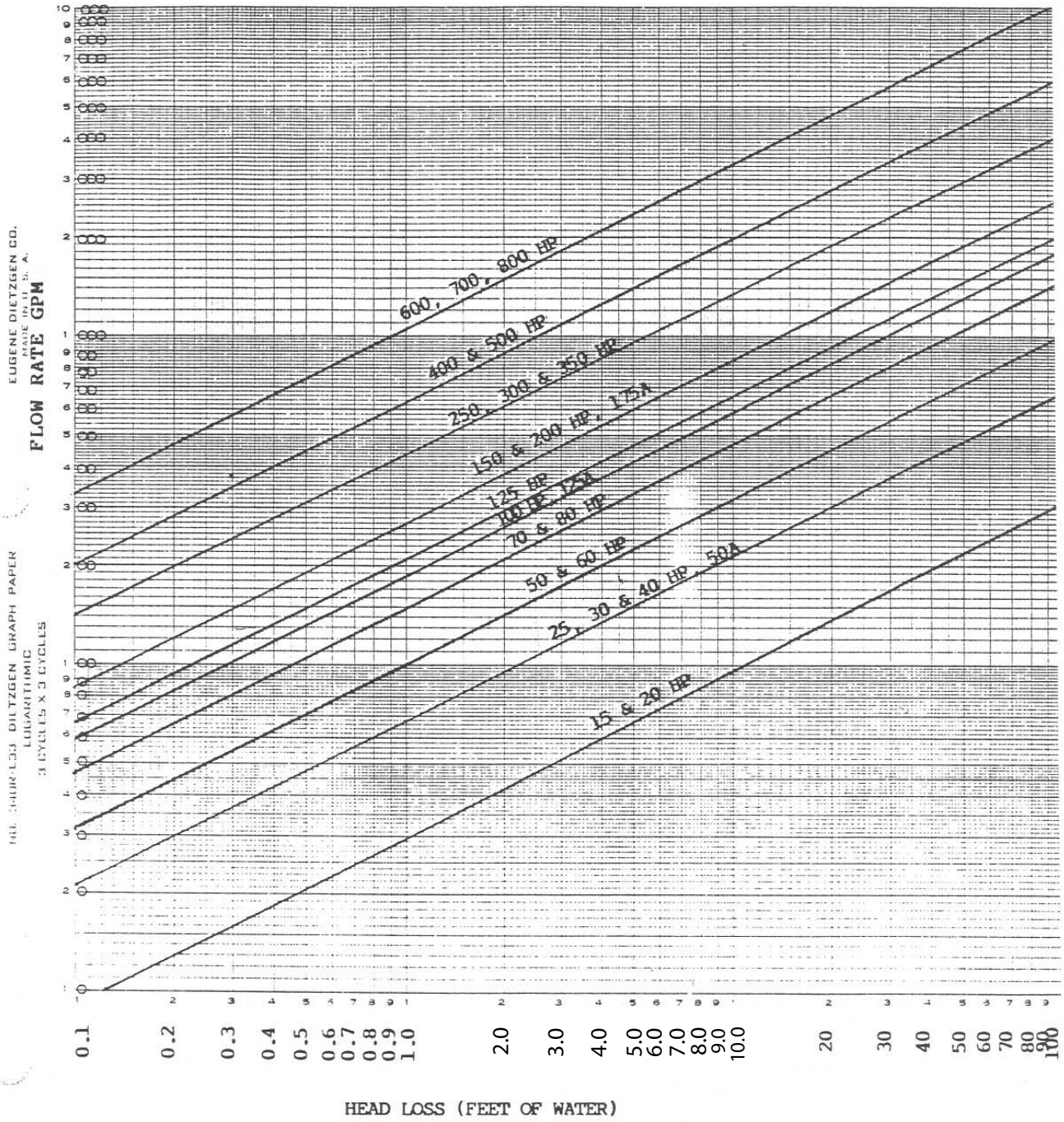

“shell” side.

Domestic water heat exchangers provide physical separation of the two media and, therefore, considerable flexibility with respect to flow and temperature. Such systems, however, are not trouble free. Scaling or fouling of the heat exchanger surface can occur, process controls can fail, etc. To maintain optimum operating efficiency of the domestic water circuit, serviceability of the equipment should always be considered during system design.

Heating/Cooling

Heating/cooling systems are often called “single pipe” systems. In a “single pipe” system, the water is either heated by a boiler or cooled by a chiller to meet the comfort demand.

Special care and consideration must be given to system design when the heating (hot water) and cooling (chilled water) systems share common distribution piping. The type of boilers selected; control systems for both heating and cooling; and type of load - heat in the morning, cooling in the afternoon - are critical issues of design consideration that will dictate success or failure of the installation.

The overall system design intent must be the comfort heating, or cooling, of the individuals who occupy the building. However, if either the boiler or chiller cannot be used because they are being repaired, the system intent has failed.

Why would a boiler or chiller fail? With respect to the boiler, consider a scenario where heating is required in the early morning and early evening. During the day, cooling is required. To meet the demand, the boiler is maintained in a hot stand-by mode. When the system demands heat, the pumps and control valves shift to send boiler water to the system. What comes back to the boiler is the “chilled” water (relatively cold) from the system. The result - THERMAL SHOCK. It is assumed that a similar, but opposite, phenomenon exists within the chiller.

What can the system designer do to minimize the potential problem when “single pipe” systems are designed?

- Provide slow acting valves that slowly bleed the system water into the boiler during the cooling/heating mode changeover.
- Specify boilers that minimize problems resulting from Thermal Shock. Refer to the Cleaver-Brooks Flextube Boiler product section, Section B1.
- Select and specify boiler operating controls and system controls that maximize equipment protection without sacrificing the heating/cooling comfort needs of the individuals.
- Possibly include accumulator tanks into the system.

Accumulators

Hot water systems inherently have considerable energy capacity. Once the heating system is “on-line,” the flywheel affect has a tendency to smooth out the minor spikes and valleys that occur during the typical heating load. However, some systems dictate the requirement for load, or heat shedding, to maximize operating efficiency or the availability of additional heat to satisfy load demand peaks. When load shedding or heat storage needs exist within the same system, an accumulator tank or heat accumulator, is an ideal fit.

When hot water systems include large demand heat users that are brought into service quickly through controls and valving, the increased load demand is immediately realized by the boiler. To minimize the impact of the condition and to

add to the total available energy for the system, accumulators or storage tanks can be used. Proper sizing of accumulator tanks requires careful analysis of the load peaks that are to be addressed and the minimum/maximum temperature swings that can be tolerated in the system.

The control system, including circulating pumps, will be dependant on the specific application of the accumulator and the design of the storage tank, such as stratification tanks and baffle tanks.

Although accumulators are not common in most heating systems, they do provide heat storage capacity and equipment protection and should be considered in complex hydronic system designs.

Safety

The highest level of consideration in any system design should be the safety of personnel. Good safety practices are essential in hot water, as well as in steam systems. For example, consideration for safe discharge of water from the relief valves is important. For hot water heating boilers (ASME Section IV; 160 psig/250 °F maximum) a flexible connection between the safety valve and the discharge pipe is recommended. The discharge piping must be properly arranged and supported so that its weight does not bear upon the valve.

High Temperature Water Boilers

As required by ASME Boiler and Pressure Vessel Code, boilers for operation over 250° F or 160 psig must be constructed in accordance with ASME Section I, Power Boilers. Due to limitations of control and safety settings, an operating temperature above 240° F will require the use of a Section I boiler.

Design pressures above 125 psig will require Cleaver-Brooks review, regardless of operating temperature. Use Figure 3 for the operating temperature and recommended minimum boiler operating pressure. Also, please ensure that there is continuous water flow through the boiler.

Depending on horsepower requirements, operating temperature, design pressure, and water flow rate, there could be some limitations that affect recommended boiler size or maximum Btu rating. Cleaver-Brooks is in a better position to review and comment on the design criteria if the evaluation is performed at the design stage of the project. Contact your local Cleaver-Brooks authorized representative on any high temperature water applications. Provide the following details for review:

- Supply and return temperatures.
- Flow rate (is it constant or variable?).
- Operating pressure.
- Describe load characteristics.
- Provide detail of system and sequence of operation.
- If a system schematic is available, forward a copy to your local Cleaver-Brooks authorized representative.

CONTROL CONSIDERATIONS

Temperature Control *Boiler Water Temperature Control*

As with all pieces of mechanical equipment, rapid changes in temperature will cause thermal stress to a boiler pressure vessel. The degree of stress and subsequent failure is directly related to the frequency and degree at which the thermal stresses are applied. Also, in hot water applications, too low of a boiler

water outlet temperature can cause condensation of flue gases and subsequent fireside corrosion. In order to avoid these types of problems, certain parameters must be considered when designing a hot water control system.

- 1. Minimum Outlet Temperature

Fireside corrosion occurs when flue gases are cooled below the dew point. Cooling of the flue gases occurs when hot flue gases come in contact with cool pressure vessel surfaces. To prevent this, minimum operating temperatures must be maintained to keep the flue gases above the dew point. The minimum water outlet temperature is typically 170 °F. The minimum return water temperature is typically 150 °F. For exact temperatures refer to the specific boiler section. Maintaining minimum outlet temperatures will help prevent harmful condensing of flue gases.

- 2. Maximum Outlet Temperature

The maximum temperature rating for all Cleaver-Brooks ASME Section IV boilers is 250 °F. Due to limitations of control and safety settings, desired operating temperatures above 240 °F may require the use of a Section I boiler and a high temperature hot water system. For high temperature water, ASME Section I, the boiler's maximum outlet temperature depends upon its design pressure. For information on high temperature water applications, contact your local Cleaver-Brooks authorized representative for further information.

- 3. Temperature Drop Across the Boiler

The maximum temperature drop from supply to return is directly related to the circulation rate through the boiler and boiler capacity. These factors must be evaluated to ensure they meet the intent of the system design. Refer to Table 1 for flow rate versus temperature drop charts.

Even though design temperature drops can be up to 100 °F, care must be taken when applying boilers into these systems. At no time should the system temperature drop provide return water at a temperature that could cause flue gas condensation and subsequent fireside corrosion.

- 4. Boiler Warm-up

The controls that maintain the boiler water temperature should be designed and set in such a way as to allow a slow warm-up of a cold boiler. To prevent damage to the pressure vessel and refractory, a warm-up from a cold (ambient) boiler to operating temperature is normally accomplished through manual operation at the low-fire rate. Automatic operation from a cold start is not recommended without proper control sequencing, as is available with the CB-HAWK control.

In multiple boiler installations when a second "cold" boiler is being brought into the system, a means should be provided to slowly introduce flow of system water into the return. The boiler's temperature should not be increased any quicker than 1 °F per minute. Even when the boiler has reached return water temperature, a means must be provided for a slow warm-up of the boiler from a stand-by to an operational condition. This will provide proper warm-up of the refractory within the boiler as well as ensure that the pressure vessel is at operating temperature. Under these conditions, a means should be provided to hold the burner in the low-fire position a minimum of 30 minutes if the burner has not operated within the last 4 hours.

- 5. Rapid Replacement of Boiler Water

The most common causes of cold water “slugs” returning to a boiler are: 1) cycling of individual zone pumps and, 2) the main circulating pump cycling off, allowing the boiler to continue to operate. These situations cause a boiler that is operating between 170 and 250 °F to experience high flow rates of possibly ambient temperature water, thus causing excessive thermal stress. To determine the rate at which cold water can be introduced into an operating boiler, refer to the specific boiler’s temperature drop/flow rate charts.

- 6. One additional item that must be considered when deciding upon boiler outlet water temperatures is boiler auxiliaries, which may require certain temperatures. For example, a hot water boiler firing a No. 6 fuel oil may require temperatures in excess of 200 °F, when heating the oil in an oil preheater with boiler water. The operating temperatures needed will depend upon the fuel oil temperatures required for proper atomization of the fuel. If water temperatures cannot be maintained at the required levels, an electric preheater must be sized accordingly to provide the additional heat.

System Temperature Control

Since the minimum outlet temperature for a boiler is limited, it is sometimes desirable to regulate the water temperature going to the heat users. This is normally done by regulating the temperature of the main supply and/or the water temperature at the heat users.

The most common way to vary the system supply temperature is through the use of a three- or four-way control valve. These control valves will blend a portion of return water with boiler supply water to maintain the desired system supply temperature. When applying these types of valves, care must be taken to ensure that the minimum flow requirements for the boiler will be met at all times. These valves must be slow moving to ensure that rapid temperature changes are not taking place in the boiler return water temperature.

Temperature control at the heat users is normally accomplished through diverting or two-position valves controlled by a room or duct thermostat. Temperature control of heat users will be discussed in more detail later in this section.

Lead/Lag Systems

A Lead/Lag system sequences the on-off firing and modulation of multiple boilers to meet the system load demand.

The key to the design of a lead/lag control in a hot water system is the realization that temperature changes in a hot water system are inherently slow. This also means that a change in boiler output does not result in immediate changes in overall system temperature. The control system must be designed to take into account the lag times and allow for fine tuning.

Lead/lag systems are available in two basic types. Lead/lag start - unison modulation and lead/lag start - lead/lag modulation.

In general, with hot water systems, lead/lag start - unison modulation would be the most practical system. This is due to the fact that with hot water boilers, the load imposed on a particular boiler is directly related to the rate of water flow through it. If the flow rate through two boilers is equal, they must have the same Btu output to maintain a constant supply header temperature. The following example illustrates

the problem associated with not having unison modulation with two equally sized boilers in a lead/lag sequence.

<u>Boiler #1</u>	<u>Boiler #2</u>
200hp	200hp
Flow = 500gpm	Flow = 500gpm
Firing rate = 100%	Firing rate = 25%

Return temperature = 160 °F

Required header temperature = 190 °F

The Btu output of a 200hp boiler at 100% firing rate is 6,695,000 Btu/hr. The same boiler's output at 25% is 1,673,750 Btu/hr. Each boiler has a flow of 500 gpm or 4071 lb/min. Since it takes 1 Btu to change 1 pound of water 1 °F, we can determine the outlet temperature of each boiler.

Boiler #1

$6,695,000 \text{ Btu/hr} \div 60 \text{ min/hr} = 111,583 \text{ Btu/min}$

111,583 Btu/min output divided by the 4071 lbs/min flow rate yields a temperature rise of 27.4 °F.

Boiler #2

$1,673,750 \text{ Btu/hr} \div 60 \text{ min/hr} = 27,895 \text{ Btu/min}$

27,895 Btu/min output divided by the 4071 lbs/min flow rate yields a temperature rise of 6.9 °F.

With a return temperature to both boilers at 160 °F, it can be seen that the outlet temperature of boiler #1 would be approximately 187 °F and the outlet temperature of boiler #2 would be almost 167 °F. Since the flow through both boilers is equal, the mixed temperature to the header would be approximately 177 °F.

This scenario becomes even further complicated when more than two boilers are in a system, and when they are of varying sizes. When the boilers are different sizes, the flow through the boilers must be proportional to the capacity and firing rate of the boilers. For example, the load on a smaller boiler may exceed rated capacity while the larger boiler is cycling off, resulting in inefficiencies and potential thermal shock damage to the pressure vessel and refractory. To ensure the flow through a particular boiler is proportional to its size and firing rate, controls and motorized valves should be incorporated. The control system required to perform this can become quite sophisticated; however, reliable operation and a savings in repair and maintenance costs will be realized.

The stand-by boiler must be kept in mind when designing a system with lead/lag operation. If there is continuous flow through all boilers, regardless of whether or not they are firing, the stand-by boiler will have an outlet temperature equal to the return temperature. This, again, will create a situation where a blended temperature is getting to the common supply header. This is normally avoided by installing a motorized valve at the outlet or return to each boiler. The position of the valve is dictated by the status of the boiler. The valve will generally have two positions. When the boiler is at header temperature and supplying hot water to the system, the valve would be at its position for maximum design flow through the boiler. When the boiler is in stand-by, the valve would be positioned for the minimum flow rate

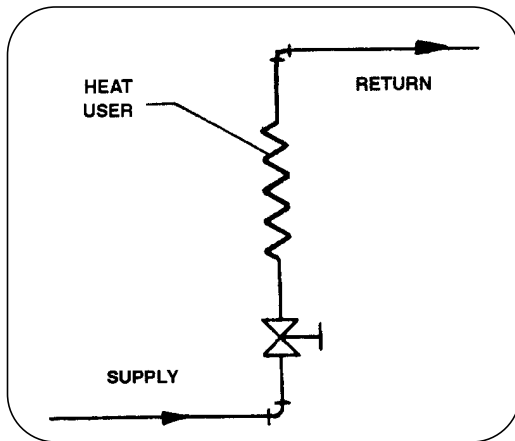

Figure 4. Plug Cock or Gate Valve (Manual Operation)

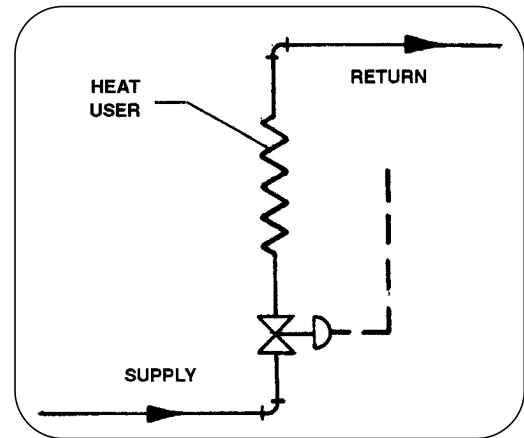

Figure 6. Throttling or Modulating Valve (Electric or Pneumatic)

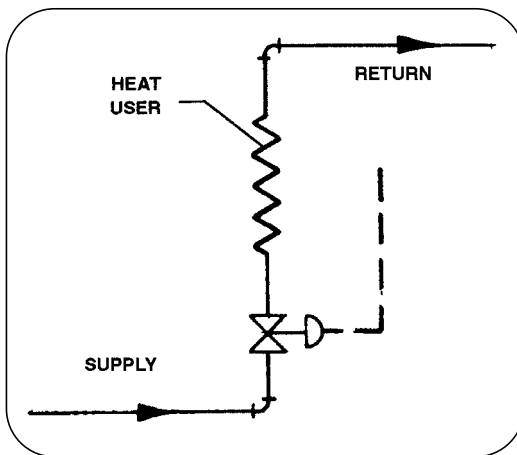

Figure 5. Two-Position Valve (Electric or Pneumatic)

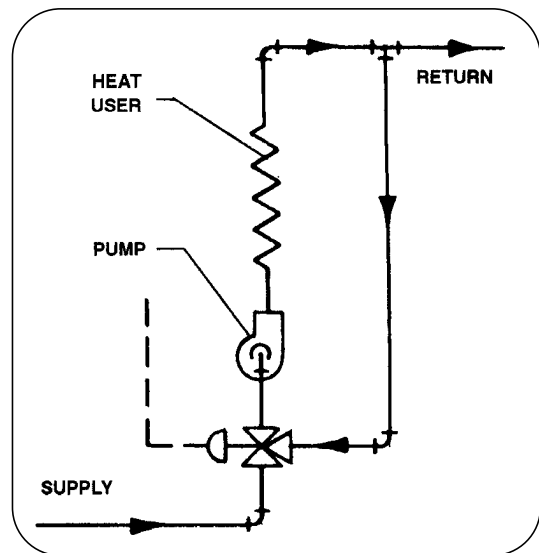

Figure 7. Three-Way Mixing Valve

required by the boiler. Maintaining the minimum flow rate will prevent stratification of temperatures within the boiler. The valve positions become more complicated and numerous when boilers of unequal sizes are applied in the same system. Keep in mind, flow through the boilers must be proportional to the output of the boilers.

Provisions should be made in the lead/lag control system to maintain a boiler in a hot standby condition. This normally requires intermittent firing at low fire to maintain a set point slightly lower than the main supply set point.

To ensure that refractory as well as the pressure vessel are at a proper operating temperature, all lead/lag controls must ensure that the burners return to low fire prior to turning the burners off. It is recommended that once a boiler is brought into the system after being off for a period of time (standby hot condition), that it be operated at its lowest firing rate for a minimum of 30 minutes.

In the interest of conserving energy, it is sometimes desirable to set back the system supply temperatures based on time of day, day of week, or outdoor air temperature. Since the boiler water temperature requires that a minimum outlet temperature be

Temperature Setbacks

maintained, resetting the boiler temperature is normally not practical. Resetting the supply water temperature is normally accomplished through a three- or four-way control valve. One important item to keep in mind when setting back temperatures, is how the control valve reacts when returning the system to the higher temperature. Control valve operation should not be instantaneous. It is extremely important to ensure that the valve does not travel from a fully closed to a fully open position instantaneously. This would cause high flow rates of relatively cold water to return to the boiler, causing thermal stress and possible pressure vessel damage.

Individual zones should not normally be set back by turning off individual circulating pumps. In determining whether or not this practice would be acceptable, the flow rate of the zone versus the entire system flow rate must be considered. If the zone has a high flow rate compared to other zones, cycling of pumps can cause serious problems with cold slugs of water being returned to the boiler, resulting in thermal stress and subsequent pressure vessel failure.

Heat Users

Selection of the type, size, quantity and location of heat users is job specific, and is usually determined by the project design engineer.

Typical load groupings are shown on the hot water system layouts shown in Figure 14 thru Figure 19. The groupings will naturally be varied, depending on actual job

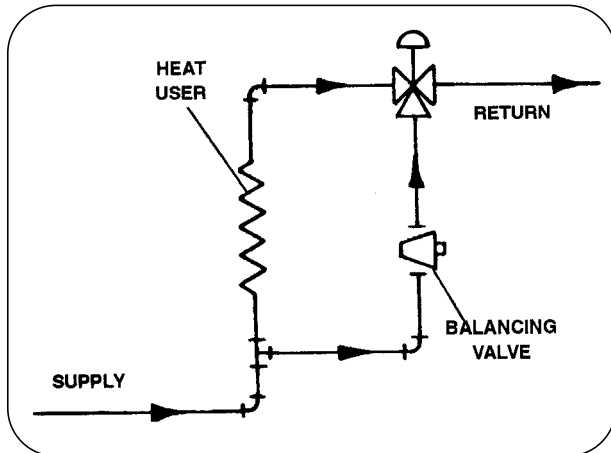

Figure 8. Three-Way Mixing Valve (By-Pass Arrangement)

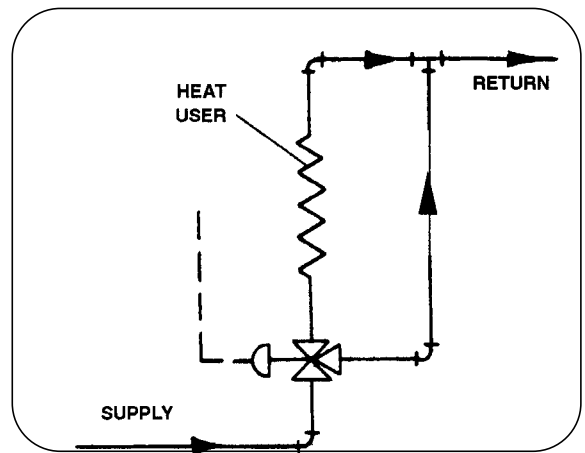

Figure 9. Three-Way Diverting Valve

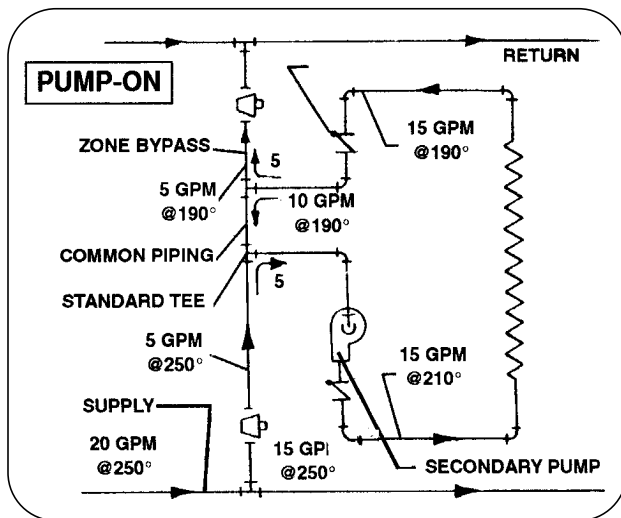

Figure 10. Intermittent Secondary Pump Operation (On-Off)

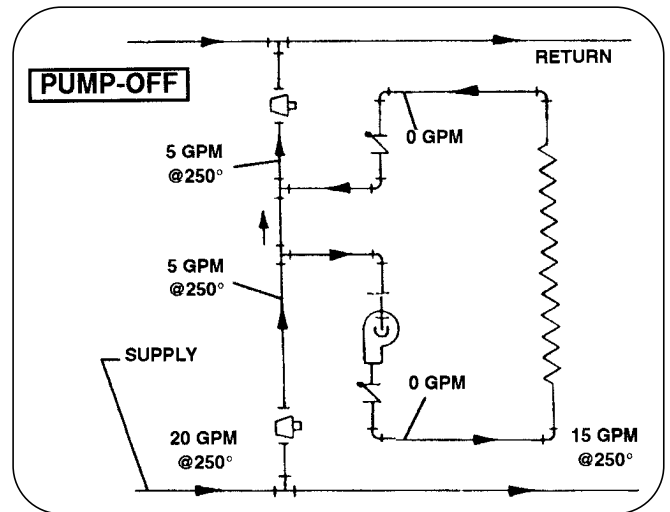

Figure 11. Water Temperature Constant Thru Zone Bypass

layout and the individual load and temperature requirements.

The following heat users are most commonly used in hot water heating systems:

1. Radiators
2. Convectors
3. Coils in Ducts
4. Fin Coils
5. Blast Coils
6. Unit Heaters
7. Unit Ventilators
8. Unit Ventilators with Face and Bypass Dampers
9. Radiant Panel - Inside
10. Process Heating

Manufacturer's installation recommendations should be closely followed to avoid special problems such as coil freeze-up, water hammer, and noise factors.

Control of Water Flow Through Heat Users

Common methods of controlling water flow through heat users are shown on the hot water layouts found later in this section and are described later.

Plug Cock or Gate Valve (Manual Operation)

Figure 4 is the simplest form of control and is directly related to physical comfort in the area adjacent to the heat user. It is commonly used on radiators, convectors, unit heaters or ventilators, and blast coils. It is sometimes used on coils and unit ventilators with face and by-pass dampers.

Sometimes an orifice gate valve is used in a non-critical area. The orifice gate valve

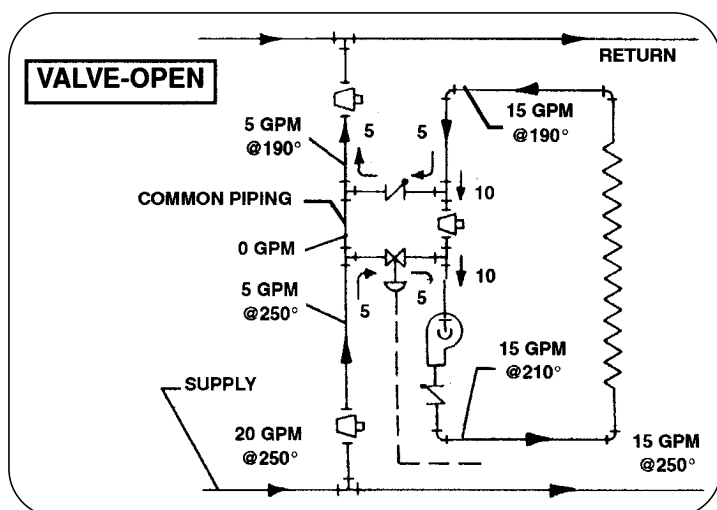

Figure 12. Continuous Secondary Pump Operation with Two-Position Valve (Valve Open)

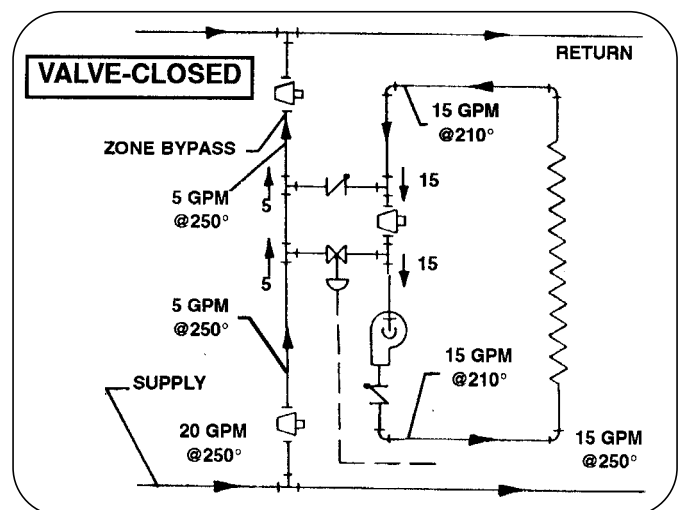

Figure 13. Continuous Pump Operation with Two-Position Valve (Valve Closed)

is recommended to ensure flow to the heat user, because it allows flow back to the boiler under all system conditions.

Two-position Valve (Electric or Pneumatic)

Two-position (fully open or fully closed) valves are commonly used to control water flow to all types of heat users. See Figure 5. The electric or pneumatic signal to the valve is usually controlled by a room thermostat or manual on-off switch in the area adjacent to the heat user.

The room thermostat or manual on-off switch in the area adjacent to the heat user will also start the fan on devices such as unit heaters.

Throttling or Modulating Valve (Electric or Pneumatic)

Throttling or modulating valves are used to control water flow to heat users such as: blast coils, unit heaters, and unit ventilators. See Figure 6. Throttling or modulating valves are preferred to two-position valves since they provide more uniform heating and a relatively constant flow of return water.

Three-way Mixing Valve

Three-way mixing valves (two inlets, one outlet) are used to control water temperatures going to inside radiant panels or process loads. See Figure 7. If a pump is used, its capacity governs the quantity of water flowing through the heat user. The pump usually operates (on-off) in response to a high limit room thermostat (without heat anticipation feature).

When used on inside radiant panels, the three-way valve is usually controlled by a room thermostat or by the temperature of the water going to the panel.

When used on process loads, the three-way valve is usually controlled by the temperature of the process itself.

Three-way Mixing Valve (By-pass Arrangement)

The three-way mixing valve with bypass arrangement (Figure 8) is commonly used on fin coils, coils, panels, and process loads and is preferred to the three-way mixing valve arrangement, since it assures a flow of return water. When fin coils or coils are controlled by a three-way valve, a room or duct thermostat usually operates the valve.

Three-way Diverting Valve

A three-way diverting valve (one inlet, two outlets) arrangement can be used in the same manner as the three-way mixing valve (by-pass arrangement). See Figure 9. In either case, the position of the valve allows more or less water to flow through the coil or through the by-pass. Either position of the valve assures return water flow to the boiler.

Primary-Secondary Pumping

1. Intermittent Secondary Pump Operation (on-off)

The secondary pump operates in response to a high limit room thermostat (without heat anticipation feature), a duct thermostat, or actual temperature of the water entering or leaving the heat user. See Figure 10.

A tee can actually be used as a mixing valve with this system. Also, wide ranges and good control of temperature drops are available to the designer. (In the example just given, there is a 60 degree drop from supply to return, but only a 20 degree drop across the heat user). When the pump is off, there is no flow in the secondary zone. The amount of water entering the zone by-pass flows through the zone by-pass to the return header.

In Figure 11, the 5 gpm at 250 degrees entering the zone by-pass leaves the zone by-pass at approximately the same temperature. If desired, the supply water temperature could be varied with an indoor-outdoor system.

2. Continuous Secondary Pump Operation (with 2-position valve)

In Figure 12, when the 2-position valve is open (admits 250 °F water), the 5 gpm at 250 °F mixes with the 10 gpm at 190 °F to supply 15 gpm at 210 °F to the pump and the heat users.

Notice

There is 0 gpm in the common piping and the return water (5 gpm) is at 190 °F. Thus, there is a 60 degree drop from supply to return, and a 20 degree drop across the heat user.

The 2-position valve could be controlled by a room thermostat or by the temperature of the water entering or leaving the heat user.

When the 2-position valve is closed, (Figure 13) the continuously operating secondary pump is circulating 15 gpm at approximately 210 °F. As long as this satisfies the load requirements, the valve remains closed.

The 5 gpm at 250 °F entering the zone by-pass line leaves the zone by-pass at approximately the same temperature.

Continuous secondary pump operation provides continuous controlled heat input into each zone.

WATER CONSIDERATIONS

Water Conditioning

Boiling Out: Initial Cleaning

Every new system will have certain harmful substances which remain in the boiler and piping after construction. It is common to find oils, greases, weld slag, and other contaminants within the system. If the foreign materials remain, the boiler could be affected by loss of heat transfer on heat exchanger surfaces and/or an acidic water condition. Boiler life may be reduced as a result of an unclean system.

Your authorized Cleaver-Brooks representative or water treatment company will be able to recommend a chemical cleaning or boil-out procedure. Also, refer to the boiler operating and instruction manual for more details.

Chemical Treatment

It is recommended that chemical treatment be provided for the initial fill of the system. Generally, chemicals will be required to prevent scale formation, promote elimination of dissolved gases and control pH.

Most hot water boilers operate in a closed system and are considered to require little attention for water treatment. Experience has shown, however, few systems can be considered completely closed. Loss of water can occur from pump packing, glands, air venting devices, and threaded or flanged pipe connections. A means must be provided to chemically treat the raw water make-up. This is generally accomplished through the use of a shot-type chemical feeder.

Make-up Water

It has been generally accepted in system design that hot water boilers are in a closed system and, therefore, no make-up water is needed. This is not always the case. Untreated make-up water is a leading cause for failures of hot water boilers. In the design stage of a hot water system, provisions must be made for properly introducing, metering, and treating make-up water.

Introducing Make-up Water

A recommended means for introducing make-up water to a hot water system is shown in Figure 1. This method ensures all air is removed from the make-up water. It also ensures the water temperature is tempered prior to being introduced to the boiler, thus reducing the risk of thermal shock.

Metering Make-up Water

The purpose of metering the make-up water to a hot water system is to prevent potential problems that can tend to damage an otherwise well planned installation. Figure 1 shows the recommended location for a water meter, which is used to measure the amount of make-up water used by the system. The meter is necessary, as it may be the only means to identify a system loss of water. Knowledge of make-up water usage will alert the operator to investigate the cause of the system water loss. This allows the operator to fix the problem and properly treat the make-up water prior to experiencing any additional problems.

In some cases, depending on the preference of the customer, no automatic means for make-up water is provided. Instead, a low water alarm is used in the expansion tank to alert the operator of a loss in system water and a need for system make-up. The operator can then diagnose the system loss and properly treat the make-up water. A low water alarm is only practical where full-time operators are employed.

Ethylene Glycol as Heat Transfer Medium

¹ on applications requiring freeze protection, a mixture of ethylene glycol and water is commonly used.

When using ethylene glycol certain design limitations are important, due to the characteristics of the fluid versus the characteristics of water. These characteristics are: Elevated saturation temperature, decreased thermal conductivity and specific heat, and increased viscosity and density. In addition, ethylene glycol degrades when it is heated above the manufacturer's specified maximum film temperature.

The following design parameters must be considered when operating with ethylene glycol solutions. For industrial watertube boiler parameters, or for conditions not covered in the following, contact your local Cleaver-Brooks authorized representative.

1. On applications requiring freeze protection, a mixture of ethylene glycol and water is commonly used.

1. Maximum Glycol Concentration

Firetube: 60%

Flexible Watertube: 60%

Model 4 Watertube: 50%

2. Maximum Outlet Temperature

Firetube: up to 300 °F

Flexible Watertube: 200 °F

Model 4 Watertube: 200 °F

3. Internal Circulation

A. For firetube boilers, the size of the supply and return connections are decreased based on the design temperature drop and the system pump gpm.

B. A minimum continuous gpm flow rate through the boiler corresponding to a 40 °F system drop is recommended. For firetube boilers operating between 250 - 300 °F, use a flow rate based on a 30 °F system drop.

4. Expansion Tank

a. An inert gas pressurizing blanket is preferred due to the over-pressure requirements.

5. Over-Pressure Required:

A. Firetube

170 - 250 °F operating temperature - recommend 40 psig minimum operating pressure.

250 - 300 °F operating temperature - recommend 100 psig minimum operating pressure.

B. Flexible Watertube - recommend 50 psig minimum operating pressure.

C. Model 4 Watertube - recommend 50 psig minimum operating pressure.

6. Depending upon the application, process boilers may need to be sized to limit continuous duty to 80% of maximum boiler rating. As a general rule, firetube boilers up to 350 horsepower and a maximum operating temperature of 200 degrees F, can be operated without consideration of Btu de-rating.

Notice

Generally, Firetube boilers up to 350 horsepower and a maximum operating temperature of 200° F can be operated without consideration of Btu de-rating.

7. A means should be provided to routinely monitor the condition of the system fluid. Frequent analysis during the first six months of operation and semi-annual checks thereafter are recommended.

8. Excessive use of inhibitors can create precipitation of solids causing reduced circulation and reduced heat transfer.

9. Always alert your local Cleaver-Brooks authorized representative of a system to be designed for glycol mix. Additional product modifications may be necessary, based on size, boiler model and operating temperature.

10. The temperature rating of the glycol is also important. In general, use a product with a minimum temperature rating of 175 degree F above the boiler operating temperature.

SYSTEM DIAGRAMS

Hot Water System Layout Schematics:

- The system layouts (Figure 14 through Figure 19) are intended to be used as a general guide for use with Cleaver- Brooks products. Many system layout combinations have not been shown.
- Typical load groupings have been shown and will naturally vary, depending on actual job layout and individual load temperature requirements.
- Reverse returns are shown, since they help equalize the paths of water flow and simplify balancing of the circuits.
- Centrifugal system circulating pumps are shown. It is assumed that these pumps are manually started and stopped and that they are electrically interlocked with the burner control circuit. The boiler cannot fire unless the circulating pumps are running.
- Balancing cocks are shown in the supply lines from each boiler to the pumps in order to help equalize or proportion flow through the boilers.
- The number and location of balancing cocks, shutoff valves, etc., to be used in the system will vary with the particular application.
- A make-up water meter must be installed in any raw water feed to the system.
- A means for introducing chemicals to the system water must be provided.
- Individual expansion tanks are shown for clarity. One expansion tank for multiple boilers is typically sufficient when sized properly.

Notice

When working with individual zone circuits, where one zone may have a large quantity of water, and where the zone circulating pump has a high gpm compared to other zones, "cooling down" of the water can cause a serious problem in rapid replacement of boiler water when the pump is started. For this reason, it is recommended that all circulating pumps run continuously to permit constant circulation through the relief or bypass device.

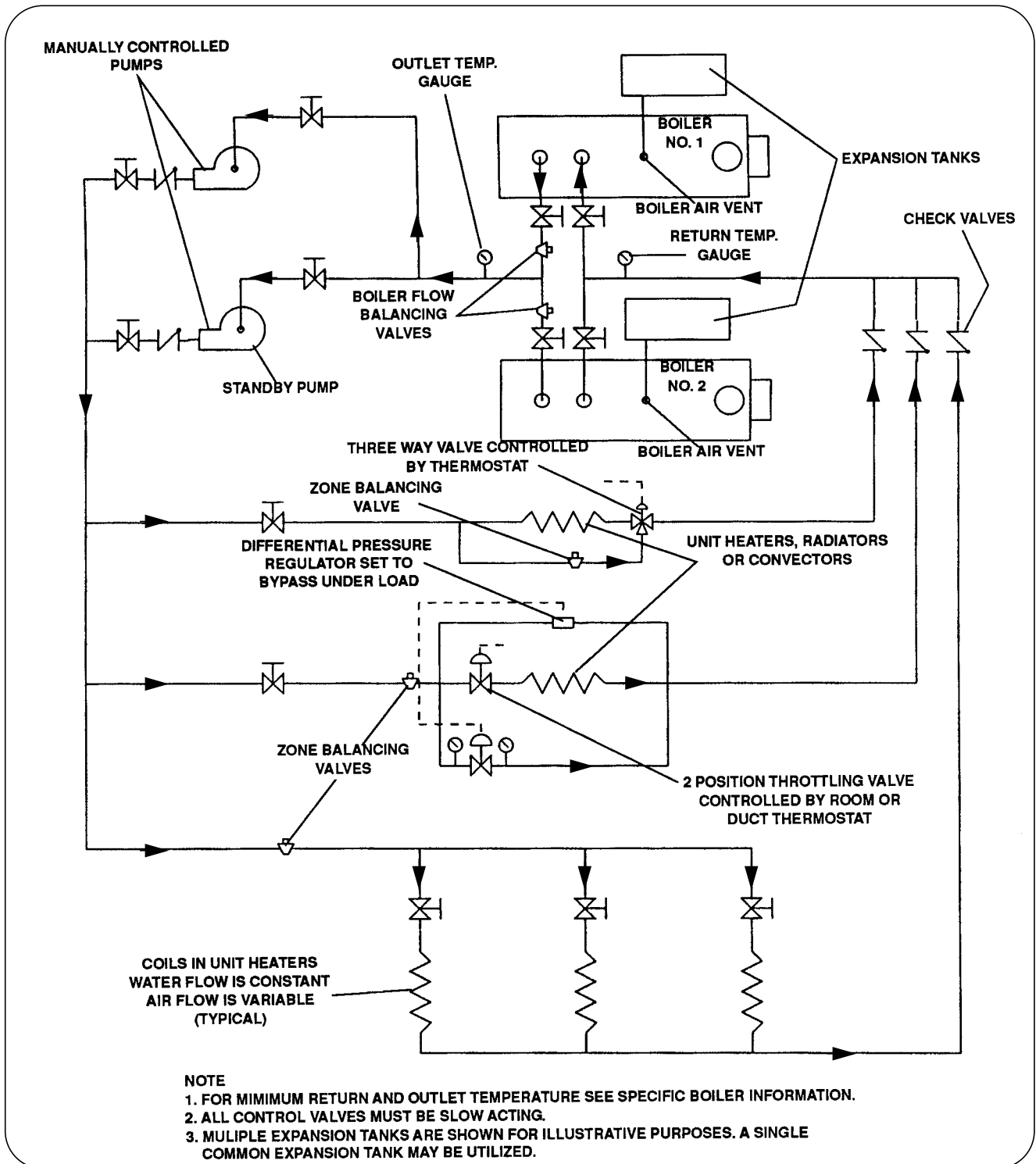

Figure 14. Primary Loop Circuit, Constant Speed Pumps

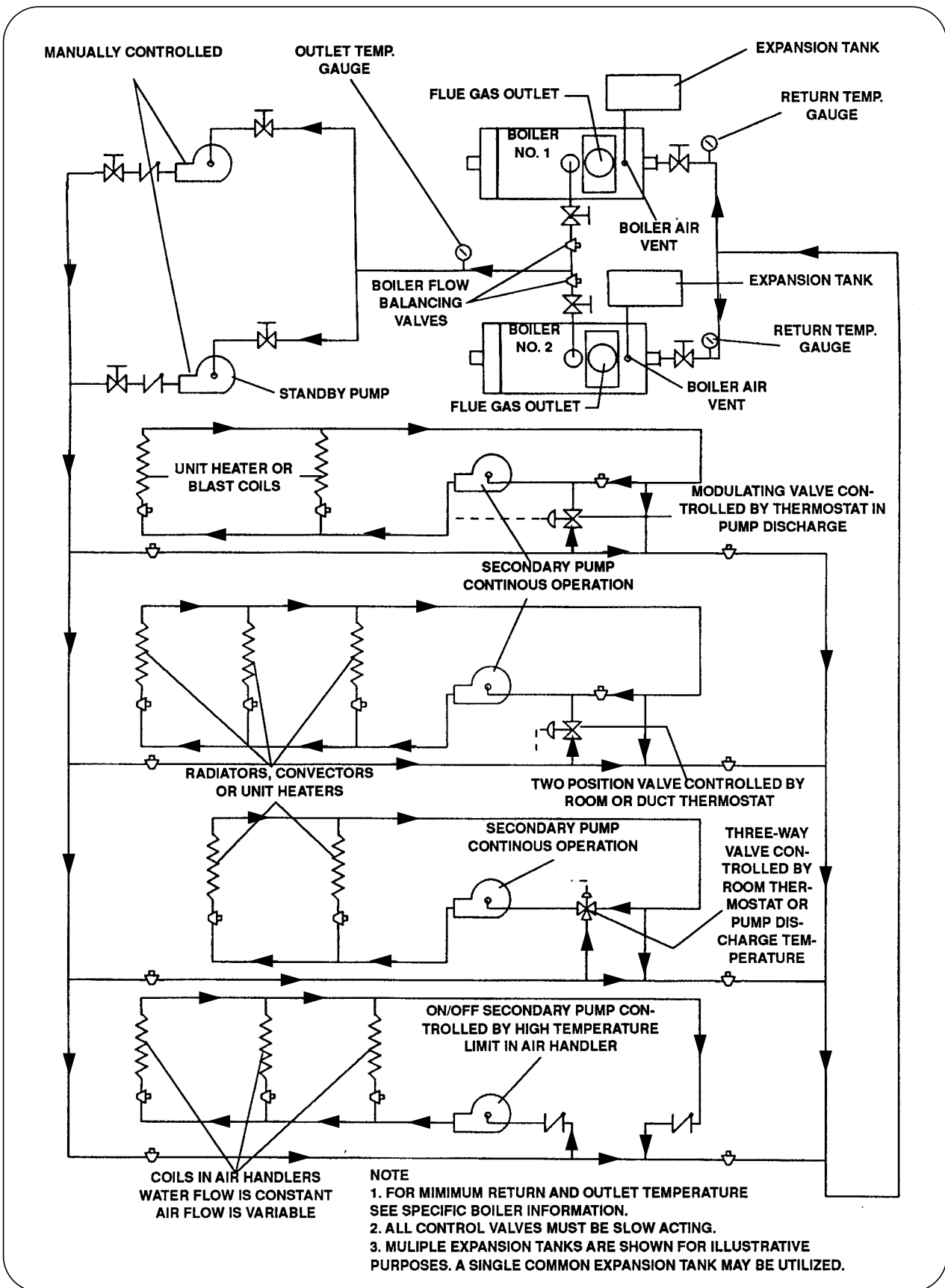

Figure 15. Primary Loop Circuit with Secondary Pumping

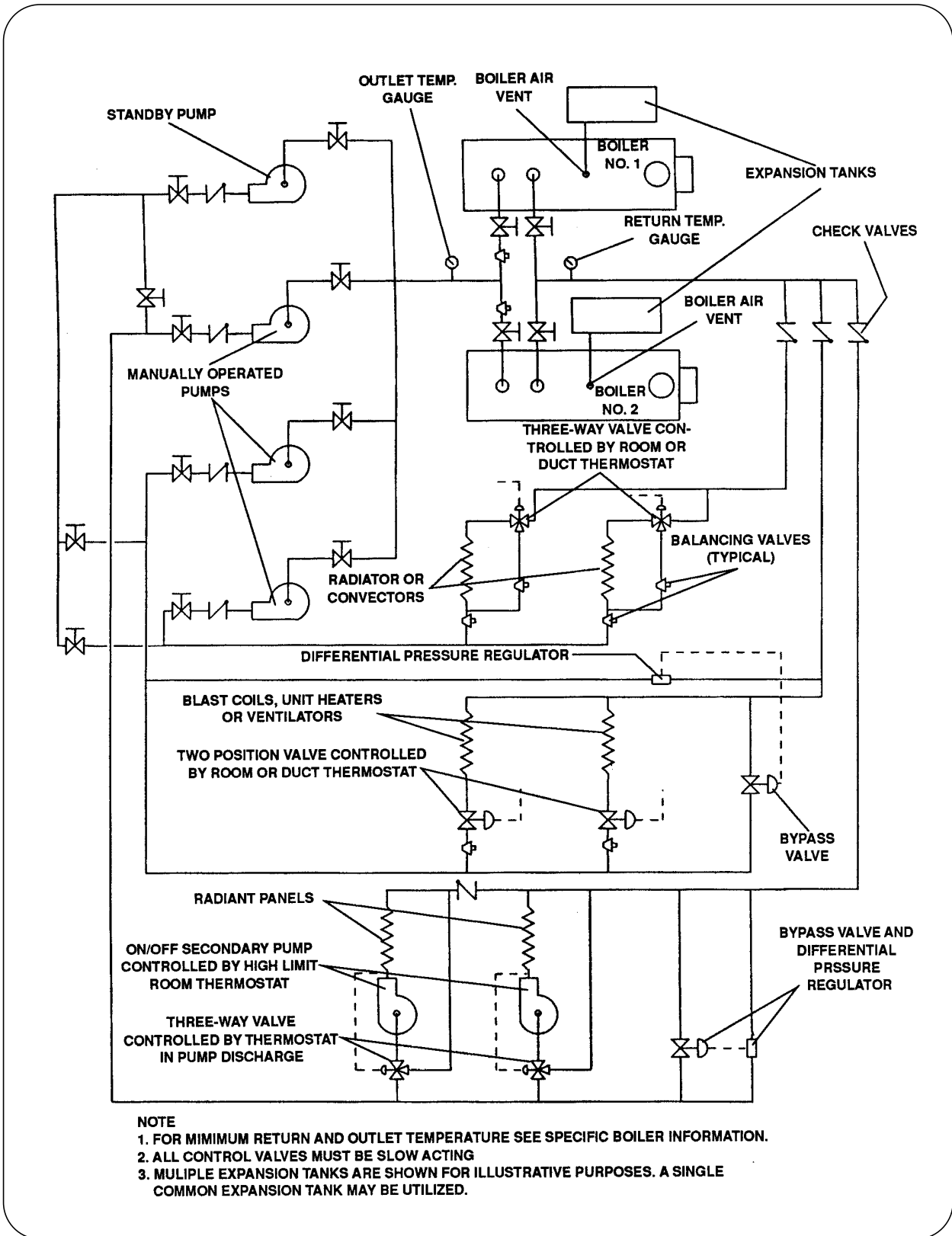

Figure 16. Individual Zone Circuits

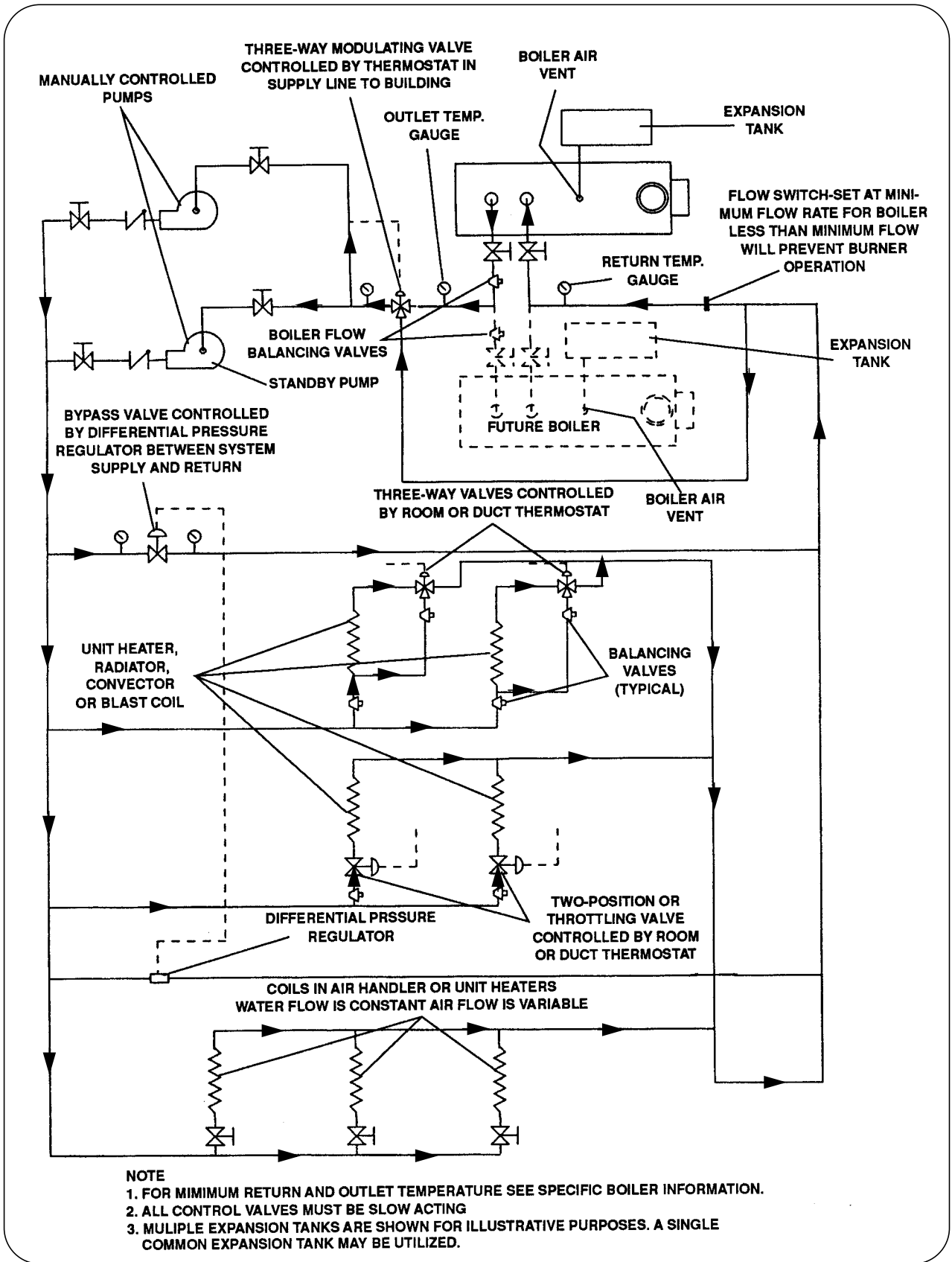

Figure 17. Primary Loop Circuit with Three-Way Valve

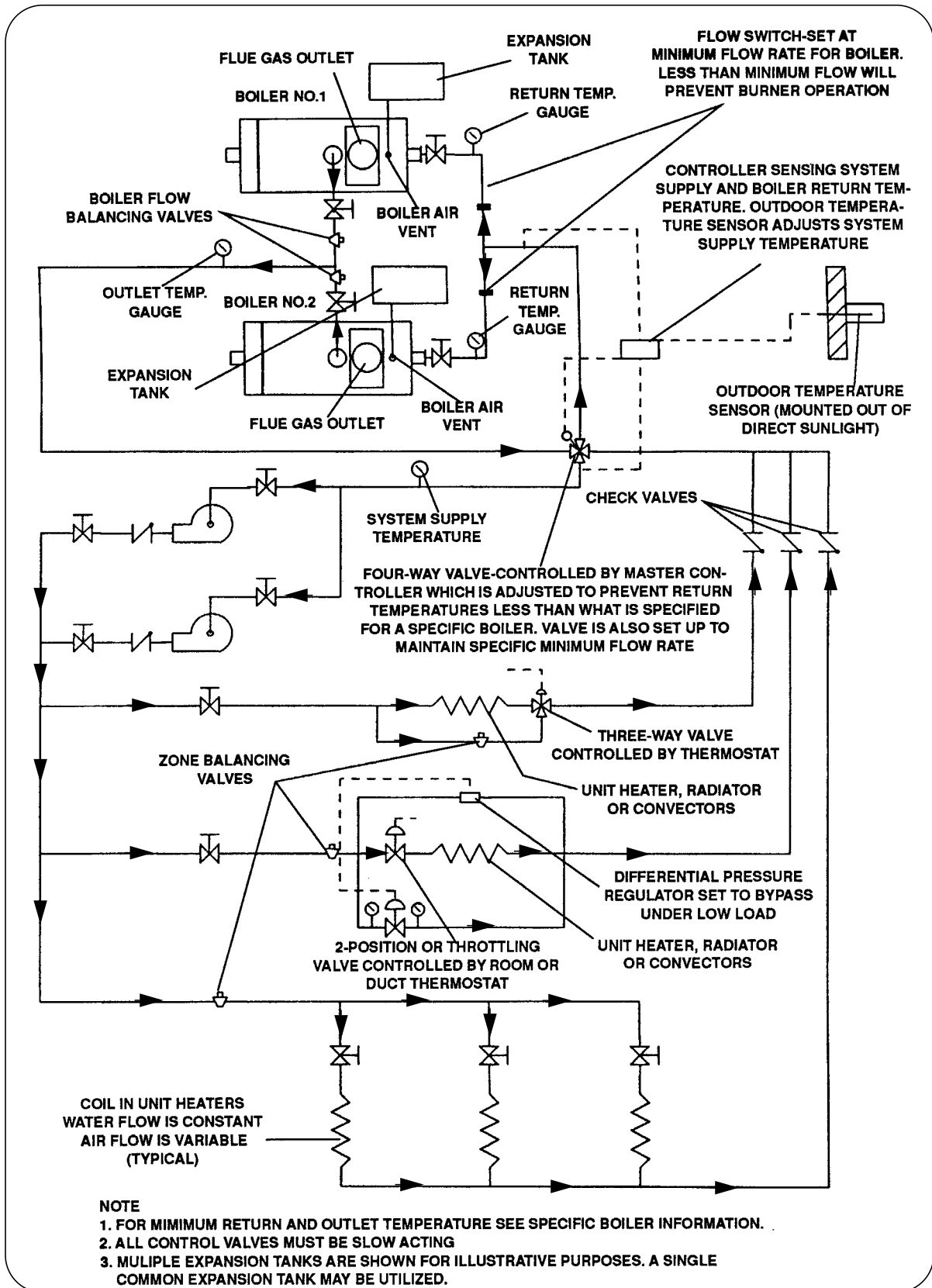

Figure 18. Four-Way Valve System

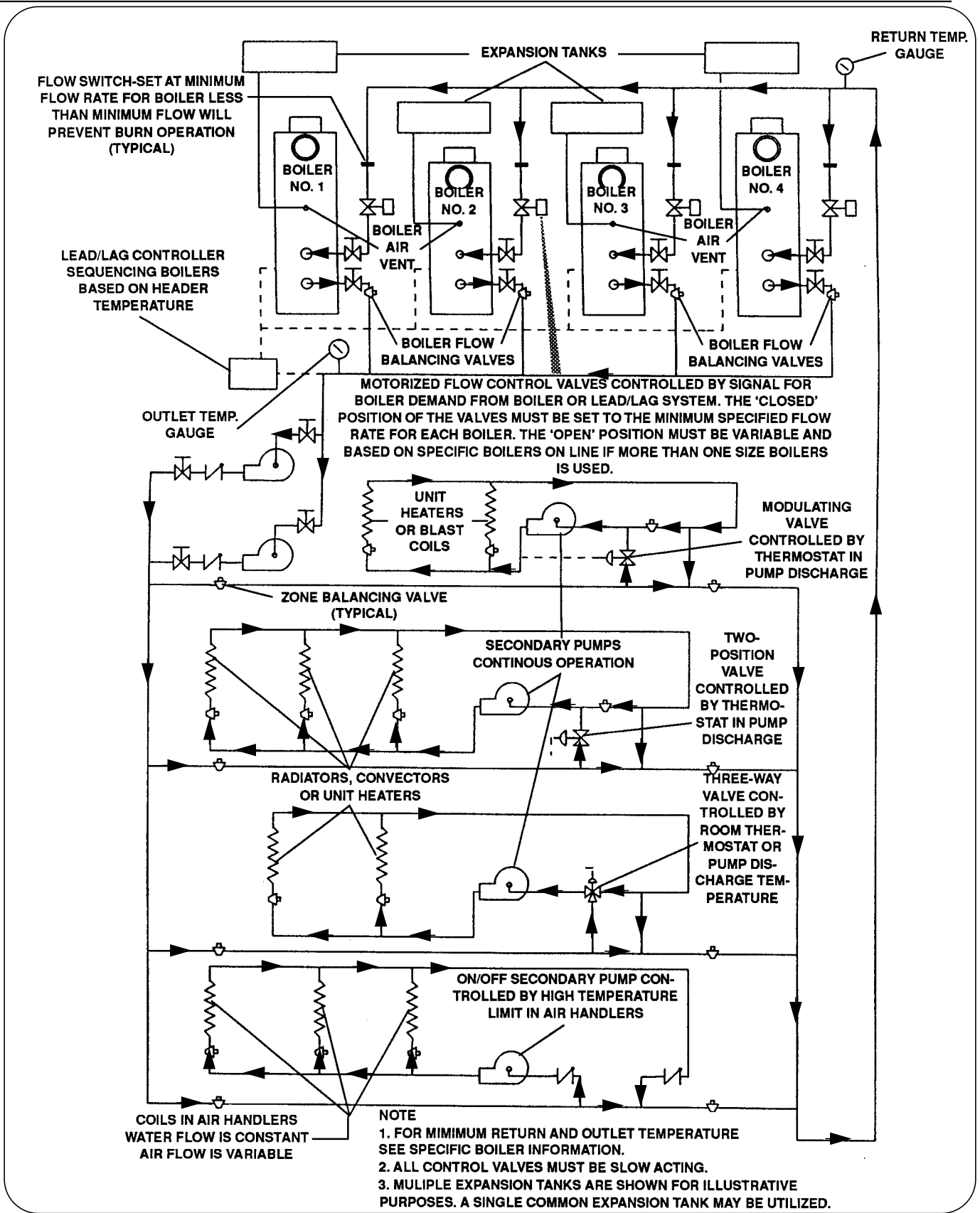

Figure 19. Multiple Boiler Lead/Lag, Primary/Secondary Pumping